

SPICE thermal model

BUK9Y29-40E

Symbol	Parameter	Conditions	Min	Typ	Max	Unit
$R_{th(j-mb)}$	thermal resistance from junction to mounting base		-	-	4.03	K/W

C_{th1}	1.143E-05 F
C_{th2}	6.442E-05 F
C_{th3}	8.376E-05 F
C_{th4}	5.754E-04 F
C_{th5}	7.288E-04 F
C_{th6}	4.439E-03 F
C_{th7}	5.310E-02 F
R_{th1}	7.880E-03 Ω
R_{th2}	1.874E-02 Ω
R_{th3}	1.106E-01 Ω
R_{th4}	2.005E-01 Ω
R_{th5}	1.150E+00 Ω
R_{th6}	2.326E+00 Ω
R_{th7}	2.122E-01 Ω

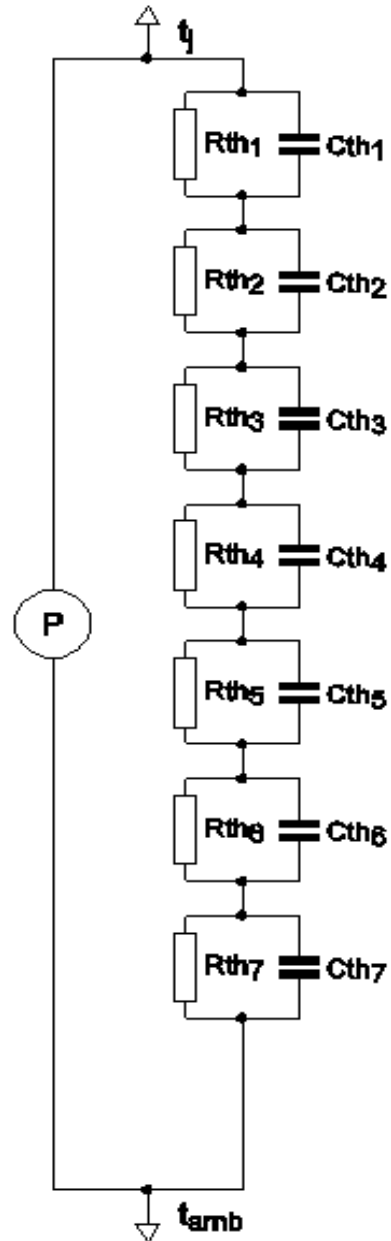

Part: BUK9Y29-40E
 Date: 25/1/2013
 Rth 4.03 K/W